

# ARREGUI

Catálogo General  
2024-2025

Buzones  
unifamiliares

- Correo
- Paquetería

Señalización  
Colectividades

Reciclaje

Taburetes

## Información general

## BUZONES

### PICTOGRAMAS



Nuevo modelo



Incluye tornillería



Apertura hacia arriba



Tamaño de sobre



Apertura hacia abajo



Conforme a la Norma Europea EN13724



Apertura lateral



**Código QR.** Descargue gratuitamente el lector apropiado para su móvil o terminal y podrá descubrir los vídeos explicativos de producto que esconde cada código QR.



Unidades por caja



Llave

### NORMA UNE-EN13724





En Noviembre de 2002 se aprueba en el CEN (Comité Europeo de Normalización) la norma sobre buzones EN13724, publicada posteriormente en 2003 y actualizada en Noviembre de 2013 en todos los países europeos, derogando todas las normativas existentes hasta ese momento.

En España Aenor publicó esta norma con la referencia UNE-EN13724 el 30 de Mayo de 2003. Su aparición en el BOE nº 205 tuvo lugar el 27 de Agosto de 2003. La norma se convierte así en el único referente del mercado europeo de buzones.

Arregui dispone de una completa gama de buzones que se sirven conforme a la norma y que se han documentado en este catálogo indicándolo en la ficha técnica de cada modelo.

### RESISTENCIA A LA CORROSIÓN

La Norma UNE-EN13724 se apoya en la Norma UNE-EN1670 de Herrajes para la edificación para establecer unos grados de resistencia a la corrosión. Esta norma clasifica la resistencia a la corrosión en 4 grados que varían desde una exposición suave en ambientes interiores habitualmente secos hasta una exposición muy severa en ambientes muy contaminados. Arregui ha realizado los ensayos según dice la Norma y ha indicado en cada referencia de buzón su grado de resistencia a la corrosión:

CLASIFICACIÓN	RESISTENCIA	ACONSEJADO EN:
Grado 1 	Baja resistencia	Ambientes normalmente secos.
Grado 2 	Moderada resistencia	Ambientes que a veces son húmedos (la mayoría de zonas rurales o urbanas).
Grado 3 	Alta resistencia	Ambientes frecuentemente húmedos y/o sujetos a una ligera contaminación.
Grado 4 	Muy alta resistencia	Ambientes en situaciones de mucha contaminación tales como las sometidas a una combinación de contaminación industrial y marina.

### PENETRACIÓN DEL AGUA

La Norma EN-13724 establece que en aquellos buzones que superen la norma, a los envíos postales depositados no les debe afectar la penetración del agua. ARREGUI ha realizado los ensayos según indica la Norma y señala en cada modelo de buzón si cumple o no con el requisito de **estanqueidad**.

### TARIFA EN VIGOR

Escanea este QR para acceder a la tarifa del catálogo.



**Arregui**  
Pol. Industrial Ubegun. 3B.  
20809 Aia-Orio. Gipuzkoa

Tfno. **Comercial:** +34 943 83 37 00  
Tfno. **SAT e incidencias:** +34 610 145 473  
arregui@arregui.es  
www.arregui.es



## Índice

### Buzones unifamiliares

- Correo
- Paquetería

### Señalización





### Colectividades

### Reciclaje

### Taburetes

## Índice

## BUZONES DE PAQUETERÍA

<b>BIGPACK BASE ELECTRÓNICO</b> Pag. 6  <span style="background-color: yellow; border: 1px solid black; padding: 2px;">NEW</span>	<b>BIGPACK BASE</b> Pag. 7 	<b>MULTIPACK BASE</b> Pag. 8 	<b>MULTIPACK BASE DOBLE ACCESO</b> Pag. 9 
---	---	---	---

## BUZONES METÁLICOS









## BUZONES ACERO / INOX



<b>SMART</b> Pag. 10 	<b>COMPACT</b> Pag. 11 	<b>LINE</b> Pag. 12 	<b>ZAGUÁN</b> Pag. 13 
--	--	---	--

## BUZONES ACERO / INOX



<b>DIME</b> Pag. 14 	<b>FLYSCH</b> Pag. 15  <span style="background-color: yellow; border: 1px solid black; padding: 2px;">NEW</span>	<b>CHANCE</b> Pag. 16 	<b>PREMIUM</b> Pag. 17 	<b>DECO</b> Pag. 18 
<b>VISIT</b> Pag. 19 	<b>VILLA</b> Pag. 20 	<b>HOME</b> Pag. 21 		

## BUZONES ACERO / INOX



<b>USA MAIL Y AMERICANO</b> Pag. 22 	<b>AURA</b> Pag. 23 	<b>URBAN</b> Pag. 24 	<b>PREMIUM MAXI</b> Pag. 25 	<b>KANGUR</b> Pag. 26 
--	--	---	---	--

## Índice

## PANERAS

**PANERA**  
Pag. 26



## BUZONES ALUMINIO



**RESIDENCIA**  
Pag. 27



## BUZONES ALUMINIO



**RESIDENCIA MAXI**  
Pag. 27



## BUZONES DE PLÁSTICO



## CLASSIC

Pag. 28



## COSTA

Pag. 29



## MININOVA

Pag. 30



## MARE

Pag. 31



## RECOGECARTAS Y BOCACARTAS



## BOCACARTAS

Pag. 32



## RECOGECARTAS

Pag. 32



## PACK

Pag. 33

BOCACARTAS  
MAXI

Pag. 34

RECOGECARTAS  
MAXI

Pag. 34

PACK  
MAXI

Pag. 35



## ACCESORIOS Y REPUESTOS

KIT FIJACIÓN  
PARA VERJAS

Pag. 36

REPUESTOS  
CERRADURAS

Pag. 36

SET  
CERRADURAS

Pag. 37



## TARJETEROS

Pag. 37



## Índice

## SEÑALIZACIÓN VIVIENDAS

CORPÓREA  
DE ACERO INOX Pag. 38

7A

## COLECTIVIDADES

## CESTAS PUBLICIDAD

CLÁSICO Pag. 39



CURVO Pag. 39



## PANELES DE ANUNCIOS

PAN 40 / 50 / 70 Pag. 40



## ESPEJOS

ESPEJOS SEGURIDAD  
Y VIGILANCIA Pag. 41

## PAPELERAS MURALES

MURALES  
18L. / 30L. Pag. 42

## CENICERO

GEO Pag. 43



## BOTIQUÍN

BOTIQUÍN Pag. 43



## RECICLAJE

ECOCLAS Pag. 44



ECOCLAS PLUS Pag. 45



STEP BIN Pag. 46



BINARY Pag. 46



## TABURETES

TABURETES  
PLEGABLES Pag. 47

NEW



## PINZA DE ALCANCE

PINZA  
DE ALCANCE Pag. 47

# Buzones unifamiliares

Fiabilidad y estilo  
en tus entregas



## Buzones de Paquetería

BIGPACK BASE  
ELECTRÓNICO

NEW



## CARACTERÍSTICAS

- **Dimensiones máx. paquete:** 470 x 460 x 240 mm.
- Resistencia anticorrosiva
- Material: Acero galvanizado
- Instalación: a suelo y pared
- Agujeros de fijación: 5 en la base y 4 en la trasera.

- Gran estanqueidad
- Tapa con apertura de 90° que permite depositar y extraer los paquetes cómodamente.



## CARACTERÍSTICAS CERRADURA ELECTRÓNICA

- **Clasificación** IP65
- **Tres niveles de gestión:** master, sub-master, usuario.
- **Modo de uso** público y privado.
- **Desbloqueo de emergencia**, mediante llave.
- Aviso de batería baja.
- **Opcional** película antibacteriana.

## MEDIDAS (mm)

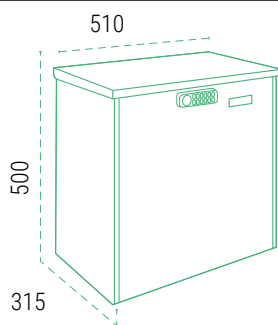

Gran capacidad.

## ACERO GALVANIZADO

NEGRO EP2104E  
EAN-8425181746639

IP65

Cerradura electrónica con clasificación IP65: estructura hermética, resistente al polvo y a la lluvia.

## INSTALACIÓN A SUELO / PARED

- CERRADURA ELECTRÓNICA.
- PARA PAQUETES MUY GRANDES.

## PARA LA ENTREGA DE PAQUETES

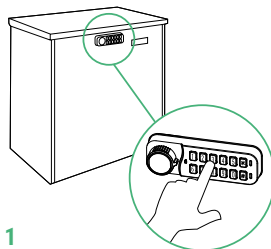

- 1 El repartidor teclea el código de apertura que el propietario del buzón haya transmitido previamente a la empresa de reparto.

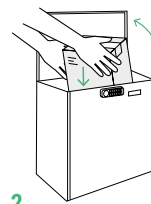

- 2 Levantar la tapa del buzón e introducir el paquete

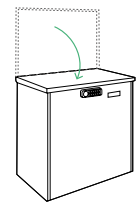

- 3 Bajar la tapa y girar el pomo en sentido anti-horario para cerrar el buzón. A los 3 segundos el buzón se bloqueará de forma automática.

## PARA LA RECOGIDA DE PAQUETES

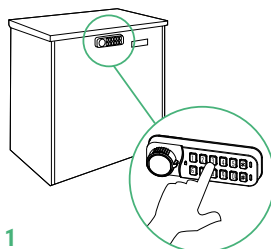

- 1 Introducir el código de apertura.

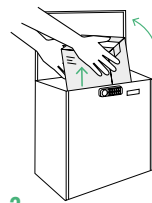

- 2 Levantar la tapa del buzón y extraer el paquete.

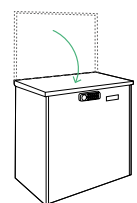

- 3 Bajar la tapa y girar el pomo en sentido anti-horario para cerrar el buzón. A los 3 segundos el buzón se bloqueará de forma automática.



## Buzones de Paquetería

## BIGPACK BASE



## CARACTERÍSTICAS

- **Dimensiones máx. paquete:** 470 x 460 x 240 mm.
- Resistencia anticorrosiva
- Material: Acero galvanizado
- Instalación: a suelo y pared
- Agujeros de fijación: 5 en la base y 4 en la trasera.

- ! Gran estanqueidad
- Tapa con apertura de 90° que permite depositar y extraer los paquetes cómodamente.
- \* La puerta se cierra mediante una cerradura de presión. Mientras el buzón permanece vacío la cerradura queda en modo abierto. Una vez que el repartidor deposita un paquete y presiona la cerradura, el buzón requiere de llave para abrirlo.

## MEDIDAS (mm)

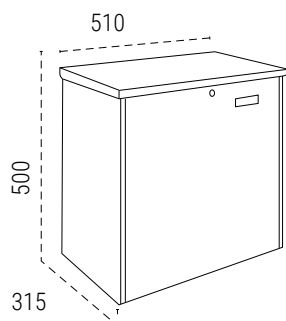

Gran capacidad.

## INSTALACIÓN A SUELO

- PARA PAQUETES MUY GRANDES.

## ACERO GALVANIZADO



**NEGRO EP2104**  
EAN-8425181738467



## PARA LA ENTREGA DE PAQUETES

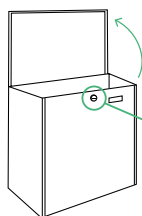

- 1**  
Levantar la tapa,  
sin pulsar la cerradura.

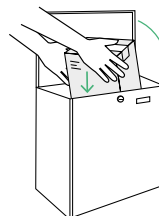

- 2**  
Insertar el paquete  
y bajar la tapa.

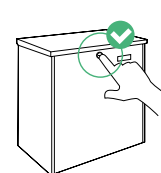

- 3**  
Presionar la cerradura  
para cerrar el buzón



**Modo cerrado,**  
no puede  
abrirse la tapa.



**Modo abierto,**  
listo para depositar  
paquetes.

## Buzones de Paquetería

## MULTIPACK BASE



## CARACTERÍSTICAS

- **Dimensiones máx. paquete:** 390 x 270 x 150 mm.
- Resistencia anticorrosiva
- Material: Acero galvanizado
- Instalación: a suelo.
- Agujeros de fijación: 4 en la base

## MEDIDAS (mm)

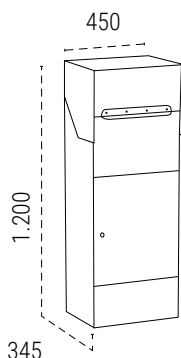

- Se pueden introducir envíos múltiples.
- 3 puntos cierre
- Gran estanqueidad
- Sistema antipesca que impide el robo de paquetes.
- Gran capacidad

## INSTALACIÓN A SUELO

- PARA PAQUETES MEDIANOS.
- PERMITE ENTREGAS MÚLTIPLES.

## ACERO GALVANIZADO



Vista frontal

**NEGRO EP3104**  
EAN-8425181738504

La boca del buzón incorpora una bandeja metálica abatible. Al abrir la tapa de boca, la bandeja se coloca en posición horizontal para recibir el paquete. Al cerrarla, éste se desliza al interior del buzón.



Los paquetes quedan asegurados en el interior del buzón. Sólo el destinatario puede recogerlos abriendo la puerta con su llave.

Seguro y robusto, con 3 puntos de cierre.

## Buzones de Paquetería

MULTIPACK BASE  
DOBLE ACCESO

## CARACTERÍSTICAS

- **Dimensiones máx. paquete:** 390 x 270 x 150 mm.
- Resistencia anticorrosiva
- Material: Acero galvanizado
- Instalación: a suelo.
- Agujeros de fijación: 4 en la base

## MEDIDAS (mm)

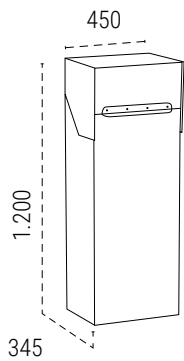

La boca del buzón queda hacia la calle y la puerta del buzón queda en el interior del muro de la vivienda, para poder extraer los paquetes desde dentro.

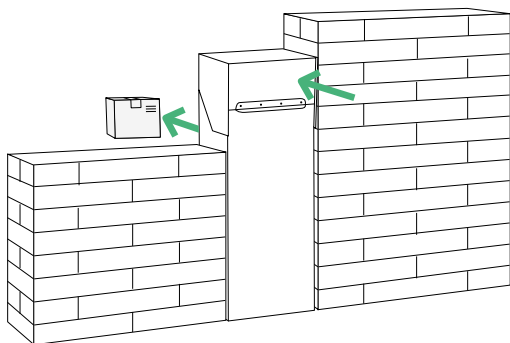

La boca del buzón incorpora una bandeja metálica abatible. Al abrir la tapa de boca, la bandeja se coloca en posición horizontal para recibir el paquete. Al cerrarla, éste se desliza al interior del buzón.

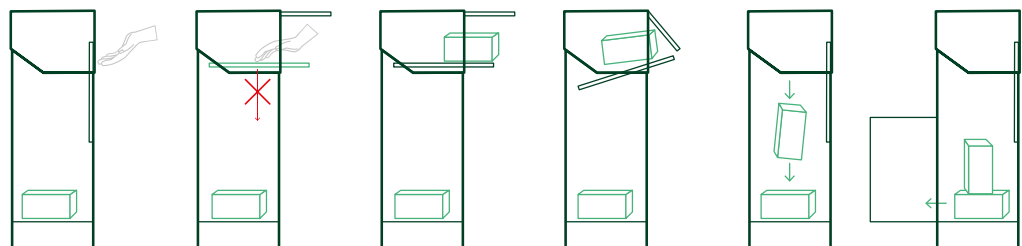

## INSTALACIÓN A SUELO

- PARA PAQUETES MEDIANOS.
- PERMITE ENTREGAS MÚLTIPLES.

## ACERO GALVANIZADO



Vista frontal

Vista trasera

**NEGRO EP3154**  
EAN-8425181738511

# Buzones acero / inox

## SMART



Capacidad



### CARACTERÍSTICAS

- Capacidad buzón DIN A-5
- Resistencia anticorrosiva INOX 🛡️🛡️🛡️
- Resistencia anticorrosiva ACERO 🛡️🛡️🛡️

### REPUESTOS

**Cerradura + Leva** CER0070  
**Tarjetero** TJO0023 (ref. E5721, E5723, E5724) / TJO0029 (ref. E5727)

- ! Ideal para espacios reducidos
- Posibilidad de utilizarlo como recogecartas gracias a su boca trasera adicional, si se combina con un bocacartas.

## ACERO INOX



**INOX E5727**  
 EAN-8425181157275

### MEDIDAS (mm)

### ACERO

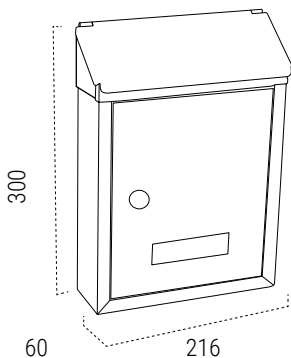

**BLANCO E5721**  
 EAN-8425181157213



**VERDE E5723**  
 EAN-8425181157237



**NEGRO E5724**  
 EAN-8425181157244



**BOCA**  
 175x20 mm

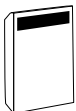

**BOCA RECOGECARTAS**  
 178x20 mm



Vista de boca recogecartas trasera



Embalaje "ready to sell"



Uso como recogecartas, combinado con un bocacartas



Buzones **acero / inox****COMPACT**

Capacidad

**CARACTERÍSTICAS**

- Capacidad buzón DIN A-5
- Resistencia anticorrosiva INOX 🛡️🛡️🛡️
- Resistencia anticorrosiva ACERO 🛡️🛡️🛡️
- Estanteidad ✔️

**REPUESTOS****Cerradura + Leva** CER0070**Tarjetero** TJO0029**SOPORTES DISPONIBLES (Pág.42)**

- Kit de fijación a verja

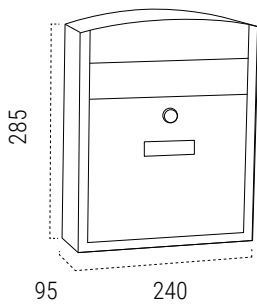
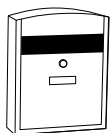

Ideal para espacios reducidos.

**ACERO INOX****INOX E5737**  
EAN-8425181157374**MEDIDAS (mm)****ACERO****BOCA**  
200x28 mm**BLANCO E5731**  
EAN-8425181157312**NEGRO E5734**  
EAN-8425181157343**VERDE E5733**  
EAN-8425181157336**ROJO E5736**  
EAN-8425181731772

Su tamaño de boca admite sobres C5.

Buzones **acero / inox**

## LINE



## CARACTERÍSTICAS

- Capacidad buzón DIN A-5
- Resistencia anticorrosiva ACERO 🛡️🛡️🛡️
- Estanqueidad ✔️

## REPUESTOS

**Cerradura + Leva** CER0068

**Tarjetero** TJO0029

## SOPORTES DISPONIBLES (Pág. 36)

- Kit de fijación a verja

- ! • Diseño de líneas rectas y actuales, perfecto para viviendas modernas.
- Con tapa superior que protege la boca y la cerradura del buzón.
- Ideal para espacios reducidos.

## MEDIDAS (mm)

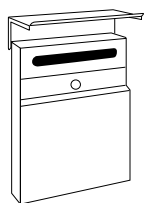
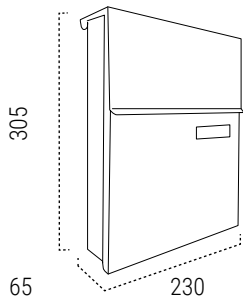

**BOCA**  
175x20 mm

## Capacidad



## ACERO



**AMARILLO E6808**  
EAN-8425181731734



**NEGRO E6804**  
EAN-8425181731710



**BLANCO E6801**  
EAN-8425181731550



La boca y la cerradura quedan ocultas y protegidas por la visera del buzón.

Buzones **acero / inox****ZAGUÁN****CARACTERÍSTICAS**

- Capacidad buzón DIN A-5
- Resistencia anticorrosiva INOX 🛡️🛡️🛡️
- Resistencia anticorrosiva ACERO 🛡️🛡️🛡️
- Estanqueidad ✔️

**REPUESTOS****Cerradura + Leva** CER0070**Tarjetero** TJO0029**SOPORTES DISPONIBLES (Pág. 36)**

- Kit de fijación a verja

- ! Posibilidad de utilizarlo como recogecartas gracias a su boca trasera adicional, si se combina con un bocacartas.
- Permite la instalación de varios buzones juntos, tanto en horizontal como en vertical, formando agrupaciones para aprovechar el espacio (no dispone de agujeros laterales de unión).

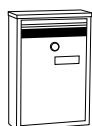
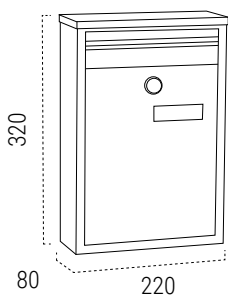
**MEDIDAS (mm)**

**BOCA**  
182x30 mm

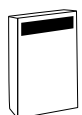

**BOCA  
RECOGECARTAS:**  
197x20 mm

**ACERO**

**BLANCO E5751**  
EAN-8425181157510

**NEGRO E5754**  
EAN-8425181157541

**VERDE E5753**  
EAN-8425181157534

**ROJO E5756**  
EAN-8425181731789

**Capacidad****ACERO INOX**

**INOX E5757**  
8425181157572



Vista de boca recogecartas trasera.



Capacidad para correspondencia tamaño DIN A5.

Buzones **acero / inox**

## DIME



## CARACTERÍSTICAS

- Capacidad buzón DIN A-4
- Resistencia anticorrosiva INOX 🛡️🛡️🛡️
- Resistencia anticorrosiva ACERO 🛡️🛡️🛡️
- Estanqueidad ✔️

## REPUESTOS

**Cerradura + Leva** CER0070

**Tarjetero** TJO0029

## SOPORTES DISPONIBLES (Pág. 36)

- Kit de fijación a verja

! Permite la instalación de varios buzones juntos, tanto en horizontal como en vertical, formando agrupaciones para aprovechar el espacio (no dispone de agujeros laterales de unión).

## MEDIDAS (mm)

## ACERO

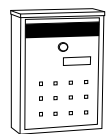
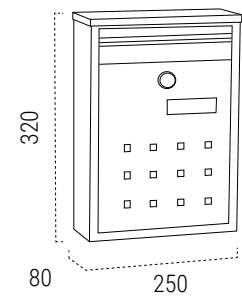

**BOCA**  
210x30 mm



**PLATA V1322**  
EAN-8425181113226



**BLANCO V1321**  
EAN-8425181113219



**NEGRO V1324**  
EAN-8425181113240



Permite agrupar varios buzones en espacios reducidos.



## Capacidad



## ACERO INOX



**INOX V1327**  
EAN-8425181113271



Buzones **acero / inox****FLYSCH**

Capacidad

**CARACTERÍSTICAS**

- Capacidad buzón
- Resistencia anticorrosiva INOX
- Resistencia anticorrosiva ACERO
- Estanqueidad
- Muy robusto
- Tapa de cierre silencioso, con sistema de amortiguación

DIN A-4

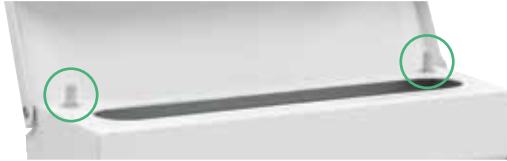
**REPUESTOS****Cerradura + Leva** CER0070**SOPORTES DISPONIBLES**

- Kit de fijación a verja

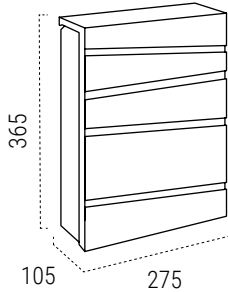
**MEDIDAS (mm)****BOCA**  
236x33 mm**ACERO****BLANCO E6921**  
EAN-8425181746677**INOX/ANTRA E6925**  
EAN-8425181746684

Buzones **acero / inox****CHANCE**

Capacidad

**CARACTERÍSTICAS**

- Capacidad buzón DIN A-4
- Resistencia anticorrosiva INOX 🛡️🛡️🛡️
- Resistencia anticorrosiva ACERO 🛡️🛡️🛡️
- Estandarización ✔️

**REPUESTOS****Cerradura + Leva** CER0131**Tarjetero** TJO0029**SOPORTES DISPONIBLES (Pág. 36)**

- Kit de fijación a verja

- ! • Con tapa superior que protege la boca del buzón.
- La cerradura queda oculta y protegida tras el embellecedor frontal.
- Con tarjetero para poder personalizar el buzón fácilmente con nombre, dirección...

**ACERO INOX**

**INOX E7107**  
EAN-8425181741764

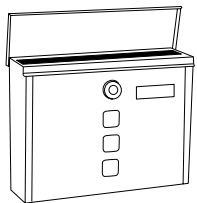
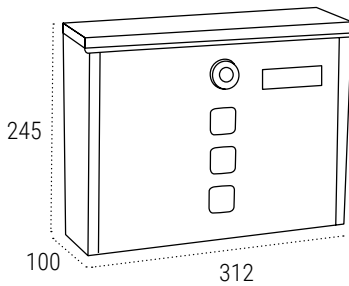
**MEDIDAS (mm.)****ACERO**

**BOCA**  
300x34 mm



**BLANCO E7101**  
EAN-8425181741740



**NEGRO E7104**  
EAN-8425181741757



La cerradura queda protegida tras la tapa.



Visores transparentes que permiten ver si hay correo en el interior.



Buzones **acero / inox****PREMIUM**

Capacidad

**CARACTERÍSTICAS**

- Capacidad buzón DIN A-4
- Resistencia anticorrosiva INOX 🛡️🛡️🛡️
- Resistencia anticorrosiva ACERO 🛡️🛡️🛡️
- Estanqueidad ✔️

**REPUESTOS****Cerradura + Leva** CER0070**Tarjetero** TJO0029**SOPORTES DISPONIBLES (Pág. 36)**

- Kit de fijación a verja

- ! • Con diseño adaptable a cualquier tipo y estilo de vivienda.
- Con tapa superior que protege la boca del buzón.

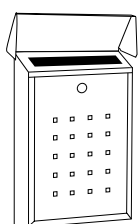
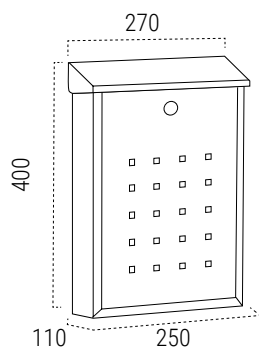
**MEDIDAS (mm)****ACERO****BOCA**  
250x34 mm**BLANCO E5601**  
EAN-8425181156018**VERDE E5603**  
EAN-8425181156032**NEGRO E5604**  
EAN-8425181156049**ACERO INOX****INOX E5607**  
EAN-8425181156070

Su medida admite correspondencia tamaño DIN A-4

# Buzones acero / inox

## DECO



Capacidad



### CARACTERÍSTICAS

- Capacidad buzón DIN A-4
- Resistencia anticorrosiva INOX ✓✓✓✓
- Resistencia anticorrosiva ACERO ✓✓✓✓
- Estanqueidad ✓

### REPUESTOS

**Cerradura + Leva** CER0070

**Tarjetero** TJO0029

**SOPORTES DISPONIBLES (Pág. 36)**

- Kit de fijación a verja

! Con diseño apaisado y con fondo estrecho, apenas sobresale de la pared.

## ACERO INOX



**INOX E5707**  
EAN-8425181157077

### MEDIDAS (mm)

### ACERO

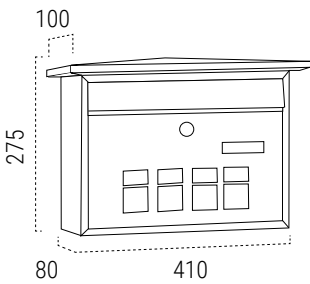

**BOCA**  
324x30mm

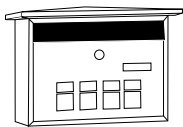

**BLANCO E5701**  
EAN-8425181157015



**NEGRO E5704**  
EAN-8425181157046



**VERDE E5703**  
EAN-8425181157039



Buzón de acero inoxidable altamente resistente a la intemperie.



Su diseño con tejadillo decora la entrada a viviendas o inmuebles.

Buzones **acero / inox****VISIT****CARACTERÍSTICAS**

- Capacidad buzón DIN A-4
- Resistencia anticorrosiva INOX 🛡️🛡️🛡️
- Resistencia anticorrosiva ACERO 🛡️🛡️🛡️
- Estanteidad ✔️

**REPUESTOS****Cerradura + Leva** CER0070**Tarjetero** TJ00023**SOPORTES DISPONIBLES (Pág. 36)**

- Kit de fijación a verja

Capacidad

**ACERO INOX**

**INOX E5747**  
EAN-8425181157473

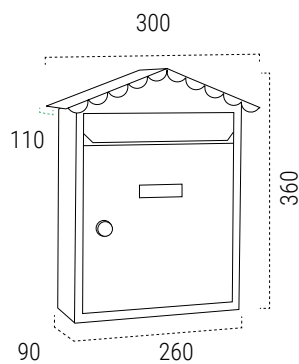
**MEDIDAS (mm)****ACERO**

**BLANCO E5741**  
EAN-8425181157411



**NEGRO E5744**  
EAN-8425181157442



**VERDE E5743**  
EAN-8425181157435

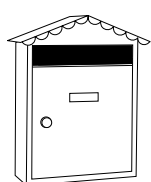

**BOCA**  
228x222mm



Con capacidad para correspondencia de tamaño din a4

# Buzones acero / inox

## VILLA



**BUZÓN DE GRAN ROBUSTEZ, MUY RESISTENTE A LOS GOLPES Y CON MUCHA DURABILIDAD.**

Capacidad



### CARACTERÍSTICAS

- Capacidad buzón DIN A-4
- Resistencia anticorrosiva ACERO 🛡️🛡️🛡️
- Estanqueidad ✔️

### REPUESTOS

**Cerradura + Leva** CER01A05CR  
**Tarjetero** TJO001

### SOPORTES DISPONIBLES (Pág. 36)

- Kit de fijación a verja

! • Bisagras inoxidables que refuerzan su resistencia a la intemperie.

## ACERO



**GRAFITO E5005**  
EAN-8425181150054

### MEDIDAS (mm)

### ACERO

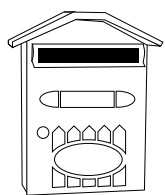
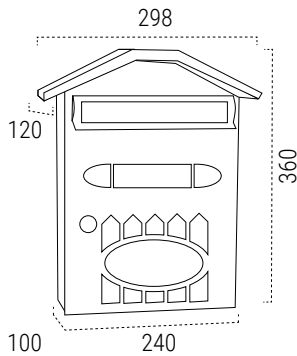

**BOCA**  
220x30mm

**BLANCO E5001**  
EAN-8425181150016

**NEGRO TEXTURADO E5004**  
EAN-8425181150047

**VERDE E5003**  
EAN-8425181150030

**ROJO INGLÉS E5002**  
EAN-8425181150023



Su diseño con tejadillo decora la entrada a viviendas o inmuebles.

# Buzones acero / inox

## HOME



Capacidad



### CARACTERÍSTICAS

- Capacidad buzón DIN A-4
- Resistencia anticorrosiva INOX 🛡️🛡️🛡️
- Resistencia anticorrosiva ACERO 🛡️🛡️🛡️
- Estanteidad ✔️

### REPUESTOS

**Cerradura + Leva** CER0070

**Tarjetero** TJO0023

**SOPORTES DISPONIBLES (Pág. 36)**

- Kit de fijación a verja

! • Con fondo estrecho, apenas sobresale y ocupa poco espacio.

MEDIDAS (mm)

ACERO

## ACERO INOX



**INOX E5717**  
EAN-8425181157176

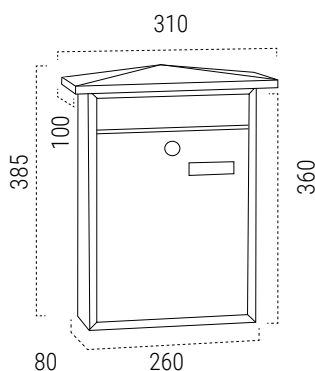

**BOCA**  
230x30mm



**BLANCO E5711**  
EAN-8425181157114



**NEGRO E5714**  
EAN-8425181157145



**VERDE E5713**  
EAN-8425181157138



Buzones **acero / inox**

**USA MAIL / AMERICANO**



Capacidad



**CARACTERÍSTICAS**

- Capacidad buzón
- Resistencia anticorrosiva ALUMINIO
- Resistencia anticorrosiva ACERO

REVISTA



**SOPORTE**

Para buzón AMERICANO E2101: soporte ref. E2112  
 Para buzón USA MAIL: soporte ref. D-USA/PL

- Sin cerradura, con la puerta siempre disponible para su apertura.
- Con bandera en el lateral, que se puede elevar para señalar que hay nuevo correo.
- De tamaño especial de gran capacidad, pudiendo albergar periódicos, revistas, catálogos, etc.
- Se puede utilizar para recibir el pan.

**AMERICANO ALUMINIO**



**SOPORTE E2112**  
 EAN-8425181121122



**ALUMINIO AMERICANO E2101**  
 EAN-8425181121016

**MEDIDAS (mm)**

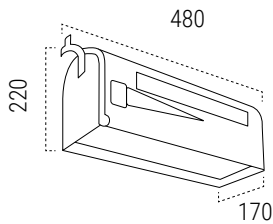

D-USA/PL

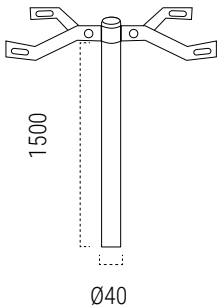

E2112

**USA MAIL ACERO**



**SOPORTE D-USA/PL**  
 EAN-8019635803537



**NEGRO D-USA/N**  
 EAN-8019635803506



**ROJO D-USA/R**  
 EAN-8019635803520

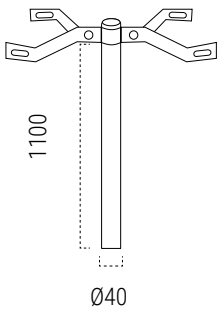

Buzones **acero / inox**



Buzones **acero / inox****AURA**

Capacidad

**CARACTERÍSTICAS**

- Capacidad buzón
- Resistencia anticorrosiva INOX
- Resistencia anticorrosiva ACERO
- Estanqueidad

REVISTA

**REPUESTOS****Cerradura + Leva** CER0069**SOPORTES DISPONIBLES (Pág. 36)**

- Soportes para instalación a suelo



- Cuerpo de acero y puerta y tapa de boca de acero inoxidable, excepto acabados blanco y negro enteramente de acero.
- De tamaño especial de gran capacidad, pudiendo albergar revistas, catálogos, sobres DIN A4, sobres acolchados, etc.

**ACERO INOX**

**INOX E5405-12**  
EAN-8425181154052

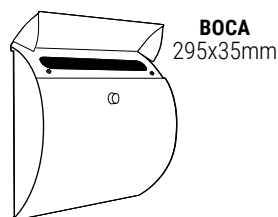
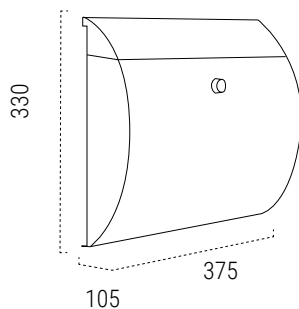
**MEDIDAS (mm)****ACERO**

**BLANCO E5401**  
EAN-8425181722930



**NEGRO E5404**  
EAN-8425181723173



El buzón Aura ha sido reconocido en diversas publicaciones de decoración.



La puerta se detiene a 75° e incluye un cajón para almacenar la correspondencia.

Buzones **acero / inox****URBAN**

Capacidad

**CARACTERÍSTICAS**

- Capacidad buzón REVISTA
- Resistencia anticorrosiva INOX 🛡️🛡️🛡️
- Estanqueidad ✔️

**REPUESTOS****Cerradura + Leva** CER0070**SOPORTES DISPONIBLES (Pág. 36)**

- Kit de fijación a verja

**!** Gran capacidad, pudiendo albergar revistas, catálogos, sobres DIN A4, sobres acolchados, etc. en posición vertical.

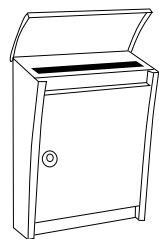
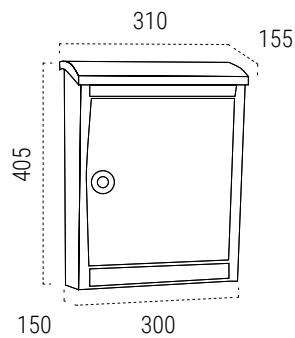
**MEDIDAS (mm)**

**BOCA**  
270x35mm

**ACERO INOX**

**INOX E5907**  
EAN-8425181159071



Gran capacidad, admite correspondencia de tamaño grande tipo revistas.



Su diseño innovador se adapta a cualquier entorno

## Buzones acero / inox

### PREMIUM MAXI



Capacidad



#### CARACTERÍSTICAS

- Capacidad buzón
- Resistencia anticorrosiva INOX
- Resistencia anticorrosiva ACERO
- Estanteidad

REVISTA



#### REPUESTOS

**Cerradura + Leva** CER0070

**Tarjetero** TJO0029

**SOPORTES DISPONIBLES (Pág. 36)**

- Kit de fijación a verja



- Con diseño adaptable a cualquier tipo y estilo de vivienda.
- Con tapa superior que protege la boca del buzón.

### ACERO INOX



**INOX E5617**  
EAN-8425181156179

#### MEDIDAS (mm)

#### ACERO

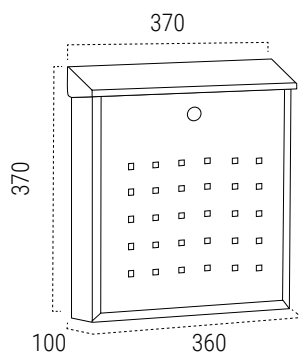

**BLANCO E5611**  
EAN-8425181156117



**NEGRO E5614**  
EAN-8425181156148

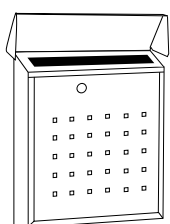

**BOCA**  
360x34 mm



Su medida admite correspondencia tamaño REVISTA



## Buzones acero / inox

## KANGUR



## CARACTERÍSTICAS

- Dimensiones máx. paquete 340x175x80 mm
- Resistencia anticorrosiva ACERO

## REPUESTOS

Cerradura + Leva CER0095

- ! Una solución que facilita la entrega y recepción de paquetes a domicilio, aún cuando el destinatario esté ausente.
- Su sistema de boca especial permite depositar el paquete en el interior del buzón con total seguridad.
- Sistema de recepción segura.

## MEDIDAS (mm)

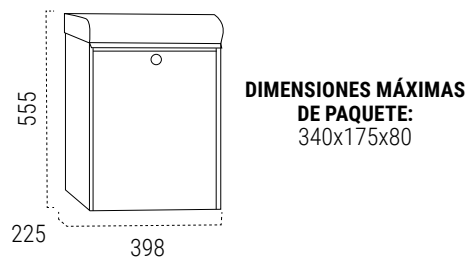

## ACERO



**SP005NG**  
EAN-8425181727089

PARA PAQUETES



La boca del buzón incorpora una bandeja metálica abatible. Al abrir la tapa de boca, la bandeja se coloca en posición horizontal para recibir la paquetería.

Al cerrar la tapa de boca, la bandeja metálica va reclinándose y sobre ella el paquete se desliza al interior del buzón.

El paquete queda asegurado en el interior del buzón de manera que sólo puede retirarlo el destinatario abriendo la puerta del buzón.

## PANERA



## CARACTERÍSTICAS

- Resistencia anticorrosiva
- Estanqueidad   
 Su tejadillo inclinado repele la entrada o filtración de agua de lluvia.

## REPUESTOS

Cerradura + leva CER05A10CR

SOPORTES DISPONIBLES (Pág. 36)

- Kit de fijación a verja

- ! En las paneras con **cerradura de llave**, es necesario solicitar una llave maestra para que los repartidores puedan abrir la puerta de la panera y depositar el pan.

## MEDIDAS (mm)

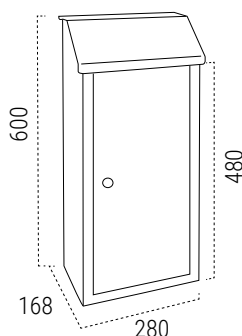

Su tamaño permite depositar varias barras de pan en posición vertical.

## ACERO GALVANIZADO

## CON LLAVE



**BLANCO SP008BN**  
EAN-8425181727645

**NEGRO SP008NG**  
EAN-8425181727652

## CON POMO



**BLANCO SP008BN-P**  
EAN-8425181741177

**NEGRO SP008NG-P**  
EAN-8425181741184

ABIERTO

CERRADO

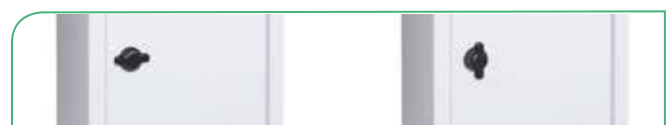

## Buzones aluminio

## RESIDENCIA



## CARACTERÍSTICAS

- Capacidad buzón DIN A-4
- Resistencia anticorrosiva 🛡️🛡️🛡️

## REPUESTOS

**Cerradura + Leva** CER0068  
**Tarjetero** TJO001

## SOPORTES DISPONIBLES (Pág. 36)

- Kit de fijación a verja

- ! • La trasera del buzón es de acero galvanizado.  
 • La tapa de boca dispone de un muelle que la mantiene cerrada.

## MEDIDAS (mm)

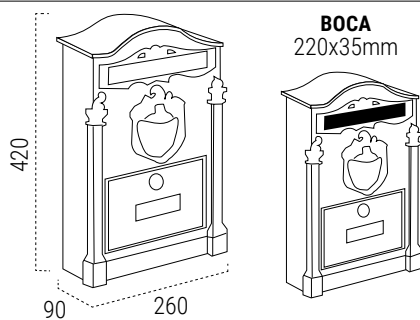

## Capacidad



## ALUMINIO



**GRAFITO E2615**  
 EAN-8425181126158



**BLANCO E2611**  
 EAN-8425181126110



**NEGRO E2614**  
 EAN-8425181126141



**VERDE E2613**  
 EAN-8425181126134

## RESIDENCIA MAXI



## CARACTERÍSTICAS

- Capacidad buzón REVISTA
- Resistencia anticorrosiva 🛡️🛡️🛡️

## REPUESTOS

**Cerradura + Leva** CER0068

- ! • La trasera del buzón es de acero galvanizado.

## MEDIDAS (mm)

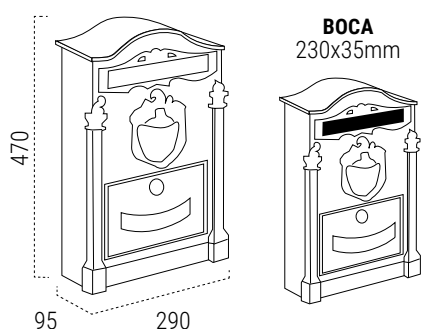

## Capacidad



## ALUMINIO



**BRONCE D-2152/B**  
 EAN-8019635804169



## Buzones plástico

## CLASSIC



Capacidad



## CARACTERÍSTICAS

- Capacidad buzón DIN-A4
- Resistencia anticorrosiva No corrosible

## REPUESTOS

Cerradura + Leva CER0107

Tarjetero TJO0033

## SOPORTES DISPONIBLES (Pág. 36)

- Kit de fijación a verja



Material: Poliestireno de gran resistencia.

## PLÁSTICO



**BLANCO E1071**  
EAN-8425181721247

## MEDIDAS (mm)

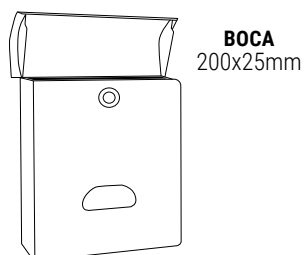
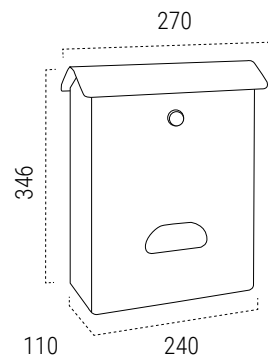

**VERDE E1073**  
EAN-8425181721025



**NEGRO E1074**  
EAN-8425181721032



## Buzones plástico

### COSTA



#### CARACTERÍSTICAS

- Capacidad buzón DIN-A4
- Resistencia anticorrosiva No corrosible
- Estanqueidad ✓

#### REPUESTOS

**Cerradura** CER02A07CR

**Tarjetero** TJO001

#### SOPORTES DISPONIBLES (Pág. 36)

- Kit de fijación a verja



Material: Poliestireno de gran resistencia.

#### MEDIDAS (mm)

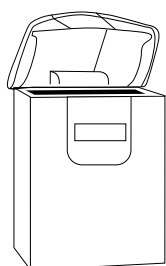
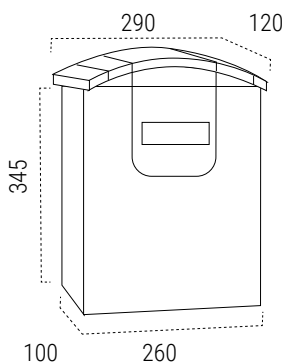

**BOCA**  
220x25mm

Capacidad



### PLÁSTICO



**BLANCO E5301**  
EAN-8425181153017



**NEGRO E5304**  
EAN-8425181153048



Embalaje "ready to sell"



## Buzones plástico

## MININOVA



## CARACTERÍSTICAS

- Capacidad buzón DIN-A4
- Resistencia anticorrosiva No corrosible
- Estanqueidad ✓

## REPUESTOS

**Cerradura + leva** CER0091

## SOPORTES DISPONIBLES (Pág. 36)

- Kit de fijación a verja

- ! • Material: Poliestireno de gran resistencia.
- La puerta se detiene a 80°.

## MEDIDAS (mm)

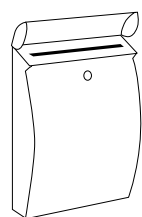
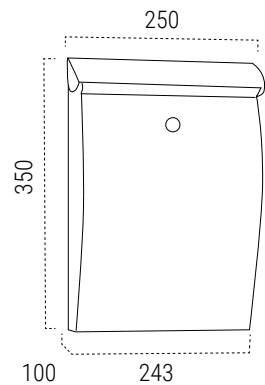

**BOCA**  
215x25mm



**VERDE E5333**  
EAN-8425181153338



**NEGRO E5334**  
EAN-8425181153345

Capacidad



## PLÁSTICO



**BLANCO E5331**  
EAN-8425181153314





## Buzones plástico

### MARE



#### CARACTERÍSTICAS

- Capacidad buzón REVISTA
- Resistencia anticorrosiva No corrosible
- Estanqueidad ✓

#### REPUESTOS

**Cerradura** CER0107  
**Tarjetero** TJO0036

**!** Material: Poliestireno de gran resistencia.

#### MEDIDAS (mm)

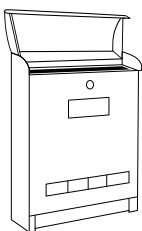
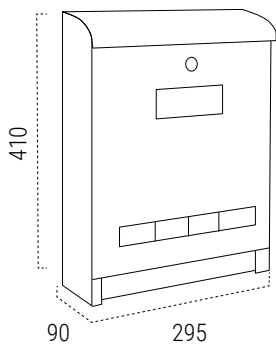

**BOCA**  
240x30mm

Capacidad



### PLÁSTICO



**BLANCO E1061**  
EAN-8425181734834



**GRIS E1065**  
EAN-8425181734841



## Recogecartas **Bocacartas**

### BOCACARTAS



#### CARACTERÍSTICAS

- Resistencia anticorrosiva INOX   
- Resistencia anticorrosiva ACERO GALVANIZADO   



- Adaptable a recogecartas V4091, V4093, V4094, V4097.
- Fabricados con acero galvanizado, de alta resistencia a condiciones exteriores.

#### MEDIDAS (mm)

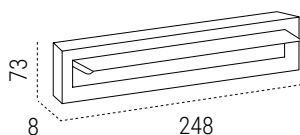







**BOCA**  
230x30mm

### RECOGECARTAS



#### CARACTERÍSTICAS

- Capacidad buzón DIN-A5
- Resistencia anticorrosiva INOX   
- Resistencia anticorrosiva ACERO   

#### REPUESTOS

**Cerradura + Leva** CER01A05CR  
**Tarjetero** TJO001



Adaptable a bocacartas C-600.

#### MEDIDAS (mm)

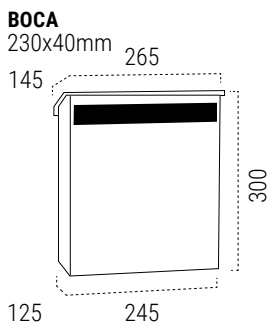

### ACERO GALVANIZADO / ACERO INOX



**INOX ESPEJO C601**  
EAN-8425181106013



**BLANCO C603**  
EAN-8425181106037



**NEGRO TEXTURADO C604**  
EAN-8425181106044



El bocacartas permite depositar la correspondencia desde el exterior de una puerta o verja.

#### Capacidad



### ACERO INOX



**INOXIDABLE ESPEJO V4097**  
EAN-8425181140970

### ACERO GALVANIZADO



**BLANCO V4091**  
EAN-8425181140918



**NEGRO TEXTURADO V4094**  
EAN-8425181140949



Es la solución ideal para la recepción de correspondencia en adosados y viviendas unifamiliares.

## Recogecartas **Bocacartas**

### PACK BOCACARTAS Y RECOGECARTAS



#### CARACTERÍSTICAS

- Capacidad buzón DIN-A5
- Resistencia anticorrosiva INOX 🛡️🛡️🛡️
- Resistencia anticorrosiva ACERO 🛡️🛡️🛡️

#### REPUESTOS

**Cerradura + Leva** CER01A05CR

**Tarjetero** TJO001

#### SOPORTES DISPONIBLES (Pág. 36)

- Kit de fijación a verja

! Conjunto formado por bocacartas y recogecartas.

Capacidad



#### ACERO INOX



Vista trasera / vista  
delantera

**INOXIDABLE ESPEJO V4037**  
EAN-8425181140376

#### MEDIDAS (mm)

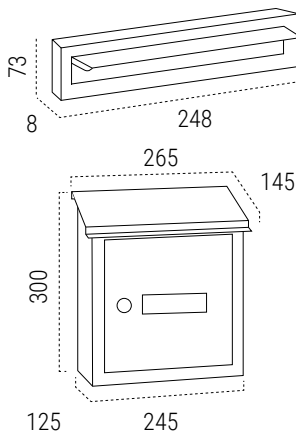

**BOCA BOCACARTAS**  
230x30mm



**BOCA RECOGECARTAS**  
230x40mm

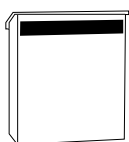

#### ACERO GALVANIZADO



**BLANCO V4031**  
EAN-8425181140314

Vista trasera / vista delantera



**NEGRO TEXTURADO V4034**  
EAN-8425181140345



La combinación de bocacartas y recogecartas es una solución que ofrece privacidad en la recepción de la correspondencia.

## Recogecartas **Bocacartas**

### BOCACARTAS MAXI



#### CARACTERÍSTICAS

- Resistencia anticorrosiva INOX   
- Resistencia anticorrosiva ACERO GALVANIZADO   

 Adaptable a recogecartas MAXI.

#### MEDIDAS (mm)

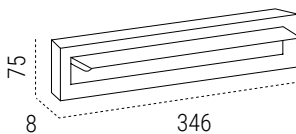







**BOCA**  
328x30mm

### RECOGECARTAS MAXI



#### CARACTERÍSTICAS

- Capacidad buzón DIN-A4
- Resistencia anticorrosiva INOX/ALUMINIO   
- Resistencia anticorrosiva ACERO GALVANIZADO   

#### REPUESTOS

**Cerradura + leva** CER01A05CR  
**Tarjetero** TJO001

#### SOPORTES DISPONIBLES (Pág. 36)

- Kit de fijación a verja

 Adaptable a bocacartas MAXI.

#### MEDIDAS (mm)

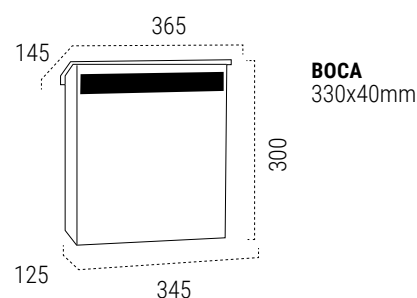

**BOCA**  
330x40mm

### ACERO GALVANIZADO / ACERO INOX



**INOX ESPEJO C611**  
EAN-8425181106112



**BLANCO C613**  
EAN-8425181106136



**NEGRO TEXTURADO C614**  
EAN-8425181106143



El bocacartas permite recepcionar la correspondencia evitando la entrada de personas ajenas a portales o inmuebles.

#### Capacidad



### ACERO INOX



**INOXIDABLE ESPEJO V4077**  
EAN-8425181140772

### ACERO GALVANIZADO



**BLANCO V4071**  
EAN-8425181140710



**NEGRO TEXTURADO V4074**  
EAN-8425181140741

### ALUMINIO



**BLANCO V4061**  
EAN-8425181140611



**NEGRO TEXTURADO V4064**  
EAN-8425181140642

## Recogecartas **Bocacartas**

### PACK MAXI



Capacidad



#### CARACTERÍSTICAS

- Capacidad buzón DIN-A4
- Resistencia anticorrosiva INOX 🛡️🛡️🛡️
- Resistencia anticorrosiva ACERO GALVANIZADO 🛡️🛡️🛡️

#### REPUESTOS

**Cerradura + leva** CER01A05CR

**Tarjetero** TJO001

#### SOPORTES DISPONIBLES (Pág. 36)

- Kit de fijación a verja

! Conjunto formado por bocacartas MAXI y recogecartas MAXI.

### ACERO INOX



**INOXIDABLE ESPEJO V4087**  
EAN-8425181140871

#### MEDIDAS (mm)

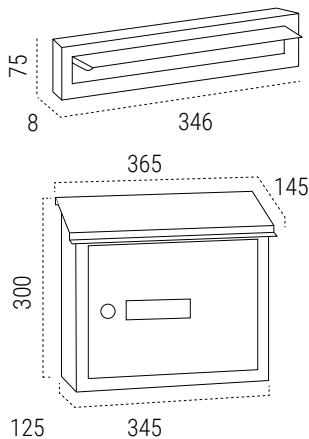

**BOCA BOCACARTAS**  
325x30mm



**BOCA RECOGECARTAS**  
330x40mm

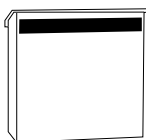

### ACERO GALVANIZADO



**BLANCO V4081**  
EAN-8425181140819



**NEGRO TEXTURADO V4084**  
EAN-8425181140840



La correspondencia se introduce por el bocacartas desde el exterior de la puerta y se recoge en el interior mediante el recogecartas.

## Accesorios y repuestos

### KIT DE FIJACIÓN PARA VALLAS O VERJAS



#### CARACTERÍSTICAS

- Material: acero
- Permite sujetar los buzones en vallas o verjas.
- Fácil instalación.
- Ideal para los buzones: Chance, Classic, Compact, Costa, Deco, Dime, Flysch, Home, Line, Mininova, Paneras, Premium, Premium Maxi, Recogecartas, Residencia, Urban, Villa, Visit y Zaguán.

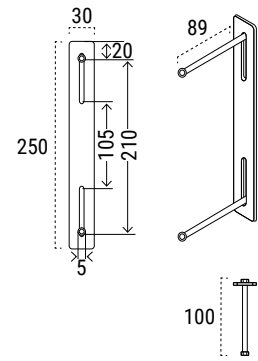

**C-015**  
EAN-8425181715161

### REPUESTOS CERRADURAS

MODELO BUZÓN	CERRADURA + LEVA		MEDIDAS LEVA D x L (mm)		FIJACIÓN
COSTA	CER02A07CR		0 x 32		RÁPIDA
RECOGECARTAS VILLA	CER01A05CR		7 x 31		
ARMARIOS DE LLAVES PL	CER0076		2 x 33		
ARMARIOS DE LLAVES PLL	CER0080		14 x 27		TUERCA
AURA	CER0069		7 x 36		
BOTIQUÍN COMPACT DECO DIME FLYSCH HOME PREMIUM PREMIUM MAXI SMART URBAN VISIT ZAGUAN	CER0070		2 x 39		
KANGUR (CON CERROJOS)	CER0095		11 x 40		
MININOVA	CER0091		4 x 46		
LINE RESIDENCIA RESIDENCIA MAXI	CER0068	13 x 38		TUERCA	
CLASSIC MARE	CER0107	8 x 45		RÁPIDA	
CHANCE	CER0131	3,5 x 45		TUERCA	

! Todas las cerraduras son CROMADAS.

L: longitud  
D: doblado

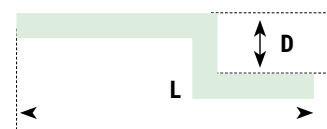

## Accesorios y repuestos

## REPUESTOS CERRADURAS

## SET DE CERRADURAS

**SET DE CERRADURA  
AGRUPACIÓN  
CER1001**

EAN-8425181810019

Para buzones de comunidad  
modelos Milenio, Infinity, Future,  
Adapta, Mira, Neo, Liberty, Básico,  
Libro, BCP, Evolution Doble y  
buzones unifamiliares modelos  
Villa, Costa y Recogecartas

**SET DE CERRADURA  
CARTERO  
CER1002**

EAN-8425181810026

Para buzones de comunidad  
dedicados a devoluciones al cartero

**SET DE CERRADURA  
MADERA  
CER1003**

EAN-8425181810033

Para buzones de comunidad  
con puerta de madera.

**SET DE CERRADURA  
EXTERIOR  
CER1004**

EAN-8425181810040

Para buzones unifamiliares  
modelos Aura, Compact, Chance, Deco,  
Dime, Flysch, Home, Line, Mininova,  
Premium, Residencia, Smart, Urban, Visit,  
Zaguan y buzón de comunidad Mira  
vertical y armarios de llaves y botiquines.

## BOLSAS DE CERRADURAS

**CER0070-10**

Bolsa de 10 cerraduras CER0070  
EAN-8425181745205

**CER0107-10**

Bolsa de 10 cerraduras CER0107  
EAN-8425181745212

**CER01A05CR-10**

Bolsa de 10 cerraduras CER01A05CR  
EAN-8425181745229

**CER02A07CR-10**

Bolsa de 10 cerraduras CER02A07CR  
(LEVA PLANA)  
EAN-8425181745236

## SET DE TARJETEROS DE PLÁSTICO

## CARACTERÍSTICAS

## • Incluye 7 tarjeteros de plástico:





- » 1 unid. TJO0001
- » 1 unid. TJO0002
- » 1 unid. TJO0004
- » 1 unid. TJO0006
- » 1 unid. TJO0023
- » 1 unid. TJO0029
- » 1 unid. TJO0033

• Adecuados para los modelos de buzones Arregui.

**TJO1001**

EAN-8425181721483

## TARJETEROS

Ref. TJO001	Buzón	Medidas tarjetero B x A (mm.)	Medidas tarjeta B1 x A1 (mm.)
	COSTA, RECOGECARTAS, VILLA, RESIDENCIA, RESIDENCIA MAXI	104 x 31	83 x 24
<b>Ref. TJO0023</b>			
	HOME, SMART (E5721, E5723, E5724), VISIT	74 x 22	65 x 17
<b>TJO0029</b>			
	COMPACT, DECO, DIME, LINE, SMART (E5727), PREMIUM, PREMIUM MAXI, CHANCE, ZAGUAN	75 x 24	65 x 14,5
<b>TJO0033</b>			
	CLASSIC	74 x 65	22 x 17
<b>TJO0036</b>			
	MARE	94 x 35	70 x 20

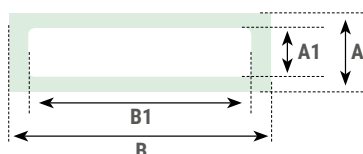

## LLAVE EN BRUTO

Ref.	Buzón
BK0007	BIGPACK BASE
BK0094	CLASSIC MARE
BK01A05CR	COSTA RECOGECARTAS VILLA
BK0074	ARMARIOS DE LLAVES AURA BOTIQUÍN CHANCE COMPACT DECO DIME FLYSCH HOME KANGUR LINE MININOVA PREMIUM RESIDENCIA SMART URBAN VISIT ZAGUÁN

## Señalización para viviendas unifamiliares

## SEÑALIZACIÓN CORPÓREA

## CARACTERÍSTICAS

- Material: Acero inoxidable satinado AISI 304 de 1 mm de espesor.
- Tipografía única: Arial. Letras mayúsculas y números del 0 al 9.
- Sistema de fijación: Se pegan a la pared mediante cinta de doble cara o silicona (no incluida).
- Medidas:
  - » De la letra **A** a la **Z**, y números del **0** al **9** en tamaño 80 mm de altura.
  - » De la letra **A** a la **F** y números del **0** al **9** en tamaños 120 mm y 200 mm de altura.
  - » **Guión** en tamaño único 45 x 13 mm.



Letras y números de acero inoxidable para señalar viviendas e inmuebles.

## TAMAÑOS



SEC11-T1



SEC11-T2

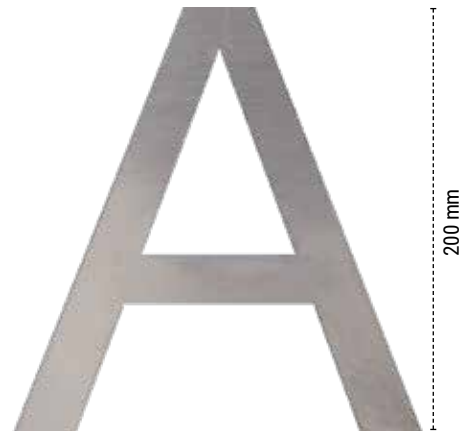

SEC11-T3

Disponible en tamaño 80 mm:

0 1 2 3 4 5 6 7 8 9

A B C D E F G H I J K L M N Ñ O P Q R S T U V W X Y Z

Disponible en tamaño 120 y 200 mm:

0 1 2 3 4 5 6 7 8 9

A B C D E F

## GUIÓN

(Tamaño único)



SEC11-T1-B - - -

## EJEMPLO DE LETRAS

A B C D E F

## NÚMEROS

0 1 2 3 4 5 6 7 8 9



## Colectividades Cestas Publicidad

### CLÁSICO

4x

#### ACERO LACADO



- Práctica: Se coloca en la entrada del edificio y evita la entrada de personas ajenas a la comunidad de vecinos.
- Permite la recogida selectiva de publicidad.
- Total visibilidad del interior.

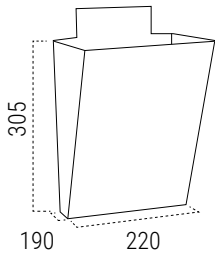

**NEGRO Y OCRE E2303**  
EAN - 8425181123034



**NEGRA E2301**  
EAN - 8425181123010



**PLATA E2302**  
EAN - 8425181123027



**BLANCO E2304**  
EAN - 8425181123041

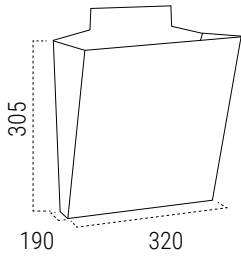

**NEGRO Y OCRE E2313**  
EAN - 8425181123133



**NEGRA E2311**  
EAN - 8425181123119



**PLATA E2312**  
EAN - 8425181123126



**BLANCO E2314**  
EAN - 8425181123140

### CURVO

4x

#### ACERO INOXIDABLE

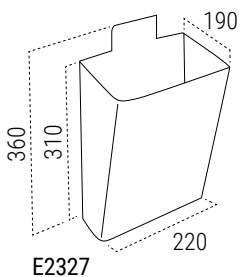

E2327



**ACERO INOX E2327**  
EAN - 8425181123270

**ACERO INOX E2337**  
EAN - 8425181123379

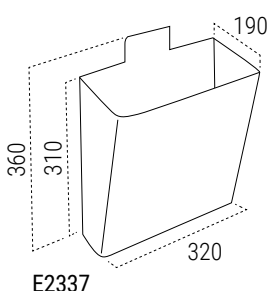

E2337



Colectividades **Paneles de anuncios****PANELES DE ANUNCIOS****CARACTERÍSTICAS**

- Material: Cuerpo de aluminio y puerta de metacrilato.

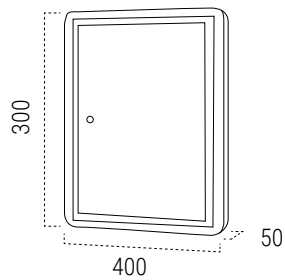

- Incluye imanes de fijación.
- Práctico: Permite fijar en ella notificaciones para la comunidad de vecinos.

**CAPACIDAD 1 DIN-A4****MEDIDAS (mm)**

**PLATA PAN52**  
EAN - 8425181100523

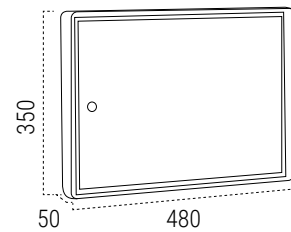
**CAPACIDAD 2 DIN-A4****MEDIDAS (mm)**

**BLANCO PAN41**  
EAN - 8425181109410



**PLATA PAN42**  
EAN - 8425181100424



**NEGRO PAN44**  
EAN - 8425181100448

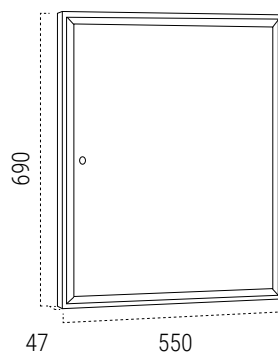

**ORO PAN46**  
EAN - 8425181100462

**CAPACIDAD 4 DIN-A4****MEDIDAS (mm)**

**PLATA PAN72**  
EAN - 8425181727836

## Colectividades **Espejos**

### ESPEJOS DE SEGURIDAD Y VIGILANCIA

#### CARACTERÍSTICAS

- Material: Espejo convexo de policarbonato. Armazón de polipropileno color negro o naranja.
- Sistema de fijación: A soporte y a pared



- Colocado en puntos estratégicos ayuda a minimizar posibles incidentes provocados por falta de visibilidad. Adecuados para la vigilancia de ángulos o zonas muertas en tiendas y supermercados, y para la seguridad vial en cruces y curvas peligrosas, salidas de garajes y espacios urbanos de reducida visibilidad.
- Resistente a la corrosión y al impacto
- Excelente calidad óptica.
- Ángulo de visión máxima: 130°

#### SISTEMA DE FIJACIÓN A SOPORTE



#### SISTEMA DE FIJACIÓN A PARED



**MIR000-30φ**  
EAN-8425181726877



**MIR001-45φ**  
EAN-8425181724897



**MIR002-60φ**  
EAN-8425181724903

Colectividades **Papeleras murales****PAPELERAS MURALES****CARACTERÍSTICAS**

- Material: acero galvanizado
- Capacidad: 18 L / 30 L

Para facilitar la recogida de los residuos depositados se recomienda la colocación de una bolsa de plástico en su interior.

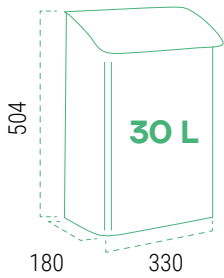
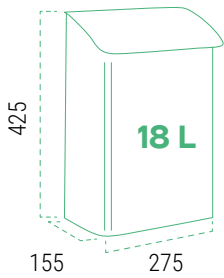
**MEDIDAS (mm)****18 L**

E6101



E6103

**30 L**

E6115



Ref.	COLOR	L	Código EAN13 8425181 *
E6101	BLANCO	18 L.	* 724286
E6103	VERDE	18 L.	* 724293
E6115	ANTRACITA	30 L.	* 738139

## Colectividades

## GEO

4x

## CARACTERÍSTICAS

- Material: Cuerpo de acero color antracita y tapa de acero inoxidable.
- Sistema de fijación: Dispone de 2 agujeros en la parte trasera con opción de amarrarlo a un lugar fijo mediante un cable o cadena.



Dispone de cubeta interior extraíble en acero galvanizado.

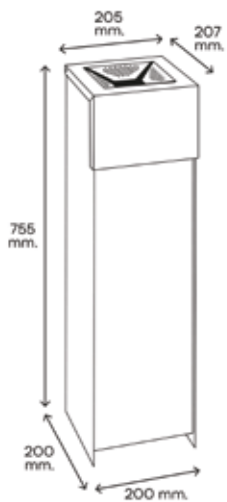

## ACERO



**GEO** E2441  
EAN-8425181124413



Cajón extraíble para recogida de cenizas.



Con opción de sujetarlo a un lugar fijo mediante cable o cadena (cadena no incluida)

## BOTIQUÍN

## CARACTERÍSTICAS

- Material: Acero lacado
- Apertura: Mediante llave de serreta
- Diseñada con dibujos contemporáneos.
- Disponen de una balda separadora que permite almacenar los medicamentos aprovechando el máximo espacio.



BT001-1



Ref.	Medida exterior (Al x An x F mm)	Medida packaging (Al x An x F mm)	Código EAN13 8425181 * * 200032
BT001-1	360x315x100	365x325x110	

## Reciclaje

## ECOCLAS



NUEVO  
TIRADOR  
LACADO INOX  
ANTIHUELLAS

## CARACTERÍSTICAS

- Material: cuerpo y frente de acero lacado color blanco. Tiradores lacados con pintura color inox antihuellas.
- Capacidad: Disponibles con 2, 3 y 4 compartimentos, con cubos de plástico removibles y con asas que facilitan su extracción y limpieza. Cada cubo tiene una capacidad de 17 l.
- Instalación: Dispone de 3 agujeros de fijación en la parte trasera. Se recomienda su fijación a pared.
- Sistema de apertura: Basculante. La apertura de cada cajón se realiza independientemente.



Se integra fácilmente en la decoración de cualquier cocina.

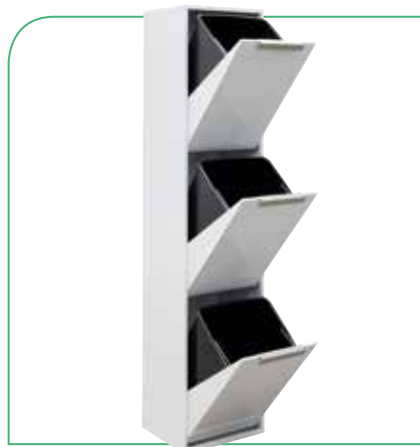

Ref. CR301-E



Tirador con acabado lacado inox antihuellas

Ref.	Nº cubos	Color	Medida ext. (Al x An x F) mm.	Kg	L	Código EAN13 8425181 *	Medida Pack. (Al x An x F) mm.
CR201-E	2	Blanco	905x305x245	11 Kg.	34 L.	* 745182	965x370x310
CR301-E	3	Blanco	1335x305x245	14 Kg.	51 L.	* 745403	1400x370x310
CR601-E	4	Blanco	905x585x245	17 Kg.	68 L.	* 745199	965x690x325
CBZ00422	CUBO	Negro	350 x 270 x 235		17 L.	* 738542	

# Reciclaje

## ECOCLAS PLUS



BANDEJA SUPERIOR para guardar bolsas, pilas, cápsulas de café, etc.

NUEVO TIRADOR LACADO INOX ANTIHUELLAS

### CARACTERÍSTICAS

- Material: cuerpo y frente de acero lacado color blanco. Tiradores lacados con pintura color inox antihuellas.
- Capacidad: Disponibles con 2, 3 y 4 cubos de plástico removibles y con asas que facilitan su extracción y limpieza, de 17 l. de capacidad cada uno. Bandeja superior para guardar bolsas, pilas, etc.
- Instalación: Dispone de 4 agujeros de fijación en la parte trasera. Se recomienda su fijación a pared.
- Sistema de apertura: Basculante. La apertura de cada cajón se realiza de manera independiente.

3 CUBOS

**NEW**

2 CUBOS

4 CUBOS



**ECOCLAS PLUS**  
CR221-E



**ECOCLAS PLUS**  
CR321-E



**ECOCLAS PLUS**  
CR621-E



Ref. CR621-E



Tirador con acabado lacado inox antihuellas



Bandeja superior para almacenar pilas, cápsulas de café, etc.

Ref.	Nº cubos	Color	Medida ext. (Al x An x F) mm.	Kg	L	Código EAN13	Medida Pack. (Al x An x F) mm.
CR221-E	2	Blanco	975x305x245	12 Kg.	34 L.	* 745052	1060x365x305
CR321-E	3	Blanco	1405x305x245	15,5 Kg.	51 L.	* 747490	1525x365x305
CR621-E	4	Blanco	975x585x245	19 Kg.	68 L.	* 745069	1105x705x330
CBZ00422	CUBO	Negro	350 x 270 x 235		17 L.	* 738542	

# Reciclaje

## STEP BIN

### CARACTERÍSTICAS

- Material: acero inoxidable y polipropileno.
- Capacidad: Disponibles con 2 y 3 compartimentos con cubos de plástico removibles y con asas que facilitan su extracción y limpieza. Cada cubo tiene una capacidad de 15 L.
- Sistema de apertura: Mediante pedal.



3 CUBOS  
CR705-45L



2 CUBOS  
CR705-30L



Cubos con asas que facilitan su extracción y limpieza.



Apertura mediante pedal.

Ref.	Nº cubos	Color	Medida ext. (Al x An x F) mm.	Kg	L	Código EAN13 8425181 *	Medida Pack. (Al x An x F) mm.
CR705-30L	2		485x410x340	5 Kg.	30L..	* 724279	510x430x370
CR705-45L	3		485x605x340	7 Kg.	45L..	* 724262	510x625x370
CR705-BIN	CUBO	Negro	400x180x235			* 738573	

## BINARY

### CARACTERÍSTICAS

- Material: acero inoxidable y polipropileno.
- Capacidad: Contiene 2 cubos de plástico de 18 y 16 litros, removibles y con asas que facilitan su extracción y limpieza.

### SISTEMA DE APERTURA

- » Cubeta superior: mediante botón.
- » Cubeta inferior: mediante pedal.



BINARY  
CR705-34L



Cubeta superior  
Apertura mediante botón.

Cubeta inferior  
Apertura mediante pedal.

Ref.	Nº cubos	Medida ext. (Al x An x F) mm.	Kg	L	Código EAN13 8425181 *	Medida Pack. (Al x An x F) mm.
CR705-34L	2	770x325x325	5 Kg.	34 L.	* 735909	780x345x325



# Taburetes

## TABURETE PLEGABLE



### CARACTERÍSTICAS

- Material: polipropileno de alta resistencia, **70% reciclado**. Incluye puntos antideslizantes de goma.
- Cómodo y manejable: Se pliega totalmente con un solo movimiento y dispone de asa para transportarlo. Puede guardarse en cualquier rincón de la vivienda, trastero, caravana...
- Resistencia: Soporta hasta 150 kg de peso.

### DISPONIBLES EN DOS COLORES

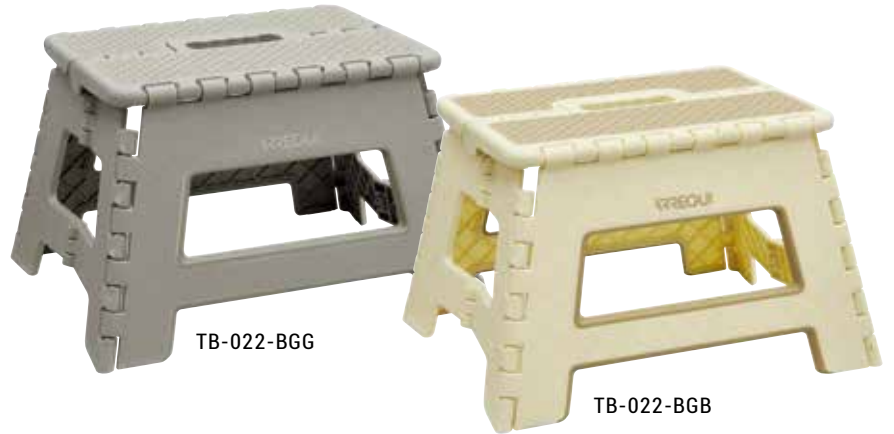

**!**  
El taburete de 39 cm de alto es idóneo para su uso como asiento para campistas, pescadores...

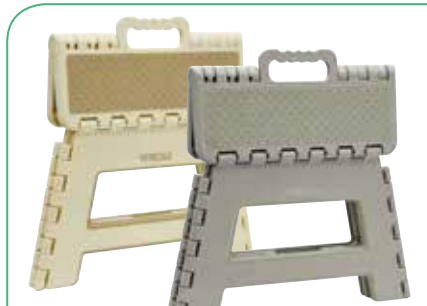

Plegable



Ref.	Color	Medida abierto. (Al x An x F) mm.	Medida plegado. (Al x An x F) mm.	Kg	Kg	Código EAN13 8425181 *
TB-022-BGG	Gris	220x290x220	370x320x40	0,67 Kg.	150 Kg.	* 747100
TB-022-BGB	Beige					* 747063
TB-027-BGG	Gris	270x290x220	400x330x40	1,16 Kg.	150 Kg.	* 747117
TB-027-BGB	Beige					* 747070
TB-032-BGG	Gris	320x290x220	450x370x40	1,46 Kg.	150 Kg.	* 747124
TB-032-BGB	Beige					* 747087
TB-039-BGG	Gris	390x290x220	520x390x40	1,52 Kg.	150 Kg.	* 747131
TB-039-BGB	Beige					* 747094

## PINZA DE ALCANCE

### CARACTERÍSTICAS

- Permite recoger objetos del suelo o a distancia sin necesidad de agacharse.
- Cabeza giratoria con pinza antideslizante e imán para recoger pequeños objetos metálicos.
- El peso máximo que la pinza de alcance puede soportar es de 1 kg.

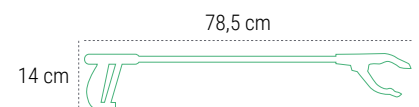

REF.	EAN13
A-1050030	8425181 * * 726679

